

FP Arm Servo
2006/7/7

10 kHz 4Pole LPF

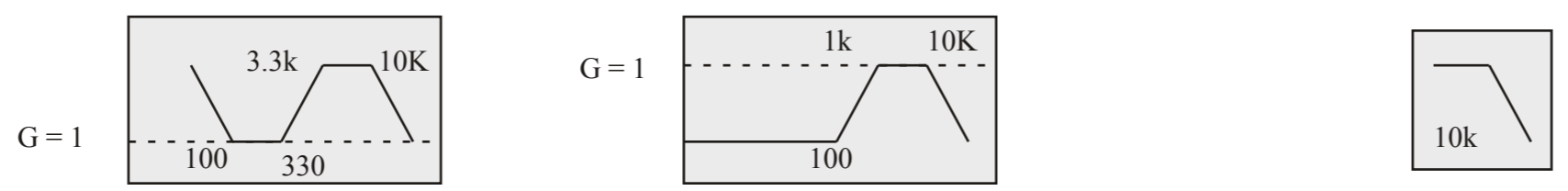
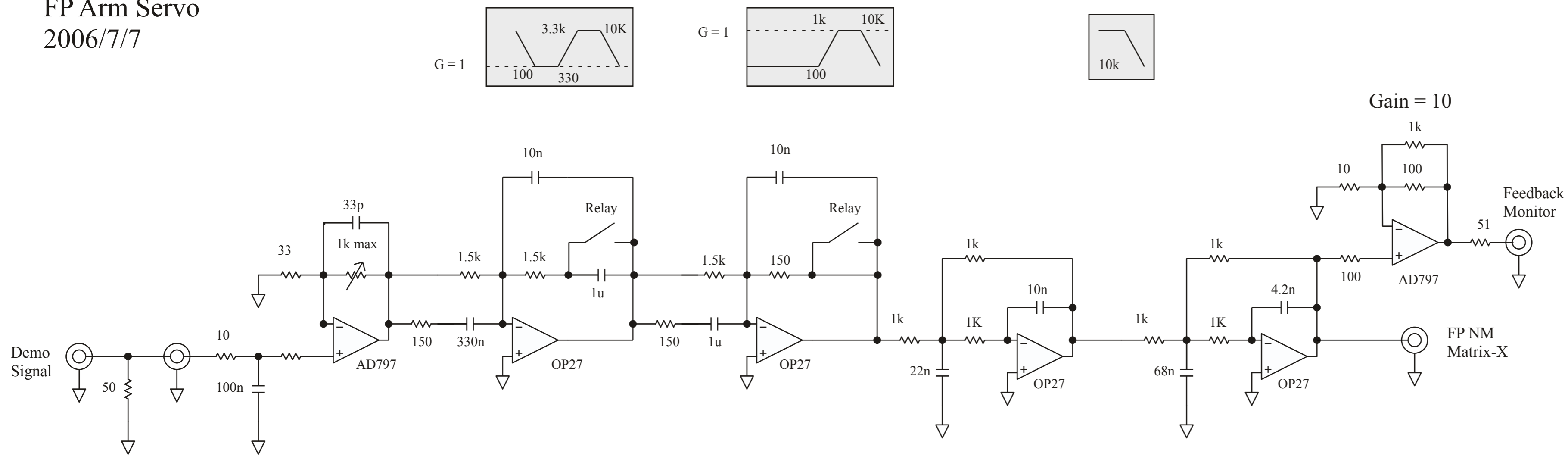

Power Supply for IC

Power Supply

